

FULL LINE OF RADIATION SHIELDING PRODUCTS



Radiation Protection Products (RPP) manufactures a full line of radiation shielding products. They include Lead Lined Doors (solid core wood, lead lined, and steel strapped), Lead Lined Drywall (otherwise known as Lead Lined Sheetrock or Lead Lined Gypsum Wallboard) and Lead Lined Plywood, Leaded X-ray Glass, Lead Lined Frames for borrowed lites and doors, pass boxes and many other lead products.

We also manufacture and install Radiation Therapy Vault Doors (Neutron Doors) and Interlocking Lead Bricks.

Radiation Protection Products uses only the finest quality material and exercises the best quality control possible.

We offer a top quality line of lead shielding products at a competitive price with delivery to satisfy your needs. For additional information concerning RPP's products or services, please contact us toll free at:

888-746-4777 PHONE
866-554-8445 FAX

ALL SHIELDING PRODUCTS PROVIDED MEET THE FOLLOWING SPECIFICATIONS:

Sheet Lead

Sheet Lead shall meet or exceed the Federal Specification QQL-201 F Grade C and ASTM B749-03 Standard Specification for Lead and Lead Alloy Strip, Sheet and Plate Products, see NCRP reports #33, #35, #49 and #147.

Gypsum Board

Gypsum Board shall meet or exceed ASTM C1396, ASTM C840, and Federal Specification SS-L-30D Grade X Type III.

Leaded Glass

Leaded Glass shall meet or exceed Federal Specification DD-G-451.

Radiation Protection Products manufactures all lead shielding products in accordance with Lead Industries Hand Book and all NCRP Applicable Reports (#33, #35, #39, #40, #49 and #147) and NBS, HB. #114.

Cassette Transfer Cabinets

Cassette Transfer Cabinets shall meet or exceed MIL-C-3673 (DM).

Wood and Plastic Laminate Doors

All Wood Doors shall meet or exceed the ANSI/NWMA Industry Standard I.S.I.-80, I.S.I.4-80, NCRP Report #49.

TERMS AND CONDITIONS OF SALES

Prices in U.S. Dollars

Prices are in U.S. dollars, F.O.B. factory, Chapel Hill, Tennessee, unless otherwise specified. Prices, specifications, and terms of sales are subject to change without notice. All orders are subject to review prior to acceptance.

Terms

Net 30 days on established accounts with approved credit. Visa/MasterCard.

Credit

New accounts, pending credit approval, may be immediately expedited by enclosing a check, wire transfer or credit card. To facilitate opening of accounts, please forward your bank and four (4) trade references. Tax-exempt or Resale Certificate required if applicable.

Minimum

Minimum invoice of \$500.00. Orders under \$500.00 may require payment by Visa or MasterCard.

Ordering/Purchasing

Your purchase order or contract is requested on all orders. All orders should be confirmed and clearly marked "Confirmation—Do Not Duplicate."

Shipment

Unless detailed shipping instructions are specified on all orders, we reserve the right to choose the method of transportation and to make partial shipments, if necessary.

Packaging/Set Up Charge

Special packaging quoted as extra. Set up charges may be applicable with certain fabrications.

Returns

Return merchandise will be accepted only with prior written authorization. Freight charges must be prepaid.



1000 Superior Boulevard, Suite 310 • Wayzata, MN 55391
1.888.RINGRPP (1.888.746.4777) • TOLL FREE FAX: 1.866.554.8445
www.radiationproducts.com

serving the nation's lead needs since **1952** with a full line of radiation shielding products

ARCHITECTS

When radiation protection is required, it is extremely important to have the designation for this material documented as clearly as possible on your drawings.

Floor plans specifying lead shielding requirements are the most concise method of designating material desired (see example on right).

To further simplify and clarify your radiation shielding requirements, and to eliminate confusion during installation, lead requirements should be specified in increments of .5mm (1/64") for all practical purposes, with a minimum thickness of .8mm (1/32"). Upon receiving the Physicist report for shielding requirements, always round up to the .5mm thickness.

Consideration should also be given to having only one manufacturer of radiation protection material. This way there is a single firm responsible for any questions that may arise concerning radiation protection.

Radiation Protection Products, Inc., as a manufacturer, has the capabilities to manufacture any and all radiation protection products which may be required. With materials specified "as manufactured by Radiation Protection Products, Inc.," you are assured of the best possible job coordination and that you are dealing with a major producer of radiation shielding material.

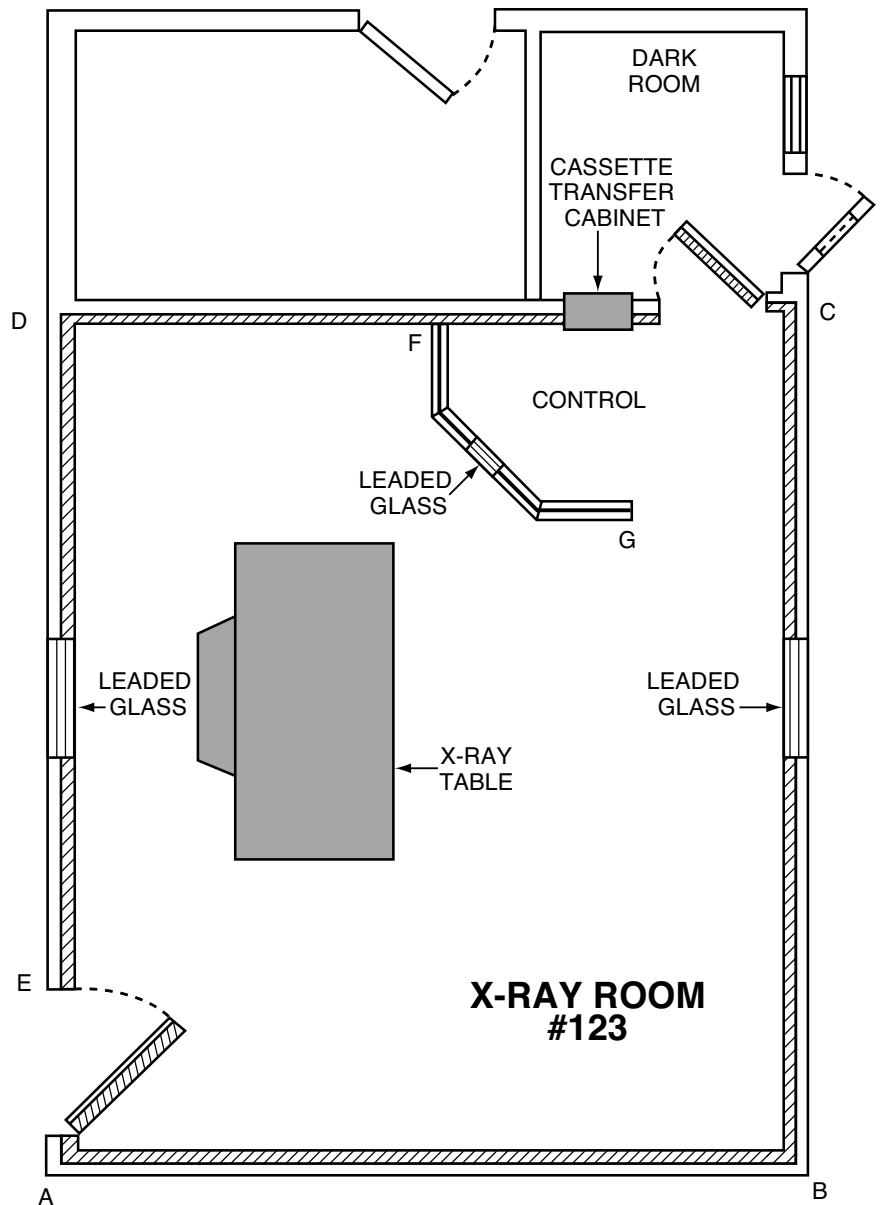

RADIATION PROTECTION SCHEDULE X-Ray Room #123



LEAD LINED
PARTITIONS

A-B	_____	MM	_____	Height
B-C	_____	MM	_____	Height
C-F	_____	MM	_____	Height
F-D	_____	MM	_____	Height
D-E	_____	MM	_____	Height
E-A	_____	MM	_____	Height
F-G	_____	MM	_____	Height



1000 Superior Boulevard, Suite 310 • Wayzata, MN 55391
1.888.RINGRPP (1.888.746.4777) • TOLL FREE FAX: 1.866.554.8445
www.radiationproducts.com

servicing the nation's lead needs since 1952 with a full line of radiation shielding products

RADIATION SHIELDING

LEAD LINED PRE-HUNG & CUSTOM DOORS

PRE-HUNG DOORS

Pre-hung Doors might be the answer for that special job. Radiation Protection Products, Inc. can supply you the door, frame, hinges, lockset or latch set and all the accessories in one package.

Radiation Protection Products uses a variety of face panels. We offer Natural Birch, Red Oak and other wood veneers plus plastic laminates. Basic lead thicknesses range from 1/32" to 1/2" in wood doors. Special order doors and door pairs are available as quoted.

Lead Lined Door Options:

- Cut out for leaded glass
- Pre-hung
- Custom wood veneer
- Plastic laminate
- 20 minute fire constructed

Orders for Doors shall include the following information:

- Width and height (specify 7'0" or 6'8")
- Finish (veneer or plastic laminate)
- Lead thickness
- Any options and locations
- Size and location of leaded glass, W x H
- On double doors, indicate which leaf to receive astragal

Complete specifications/drawings upon request.

FIRE RATED

Radiation Protection Products' fire rated lead lined doors are 20 minute constructed as certified by Intertek.

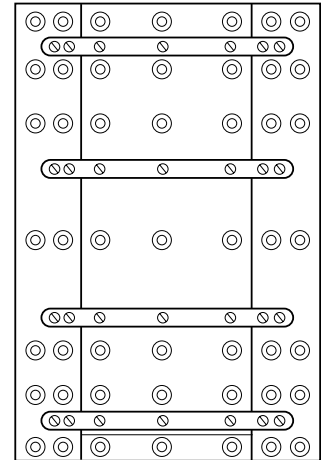
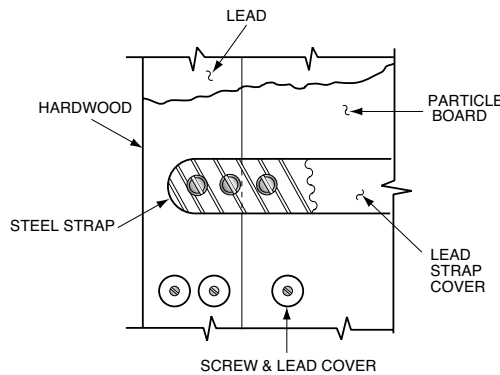
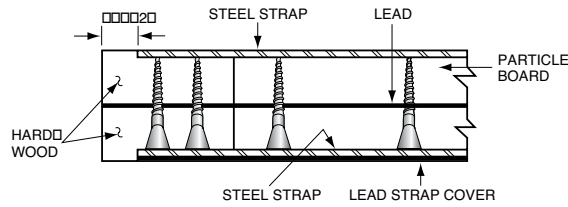

20 MIN. FIRE RATED CORE



1000 Superior Boulevard, Suite 310 • Wayzata, MN 55391
1.888.RINGRPP (1.888.746.4777) • TOLL FREE FAX: 1.866.554.8445
www.radiationproducts.com

serving the nation's lead needs since 1952 with a full line of radiation shielding products

RADIATION SHIELDING

LEAD LINED SOLID CORE WOOD DOORS

Radiation Protection Products' Lead Lined Doors are manufactured using only the finest materials and workmanship available. With constant quality control and ongoing inspection, you are assured of receiving the strongest and most functional Lead Lined Doors possible.

Radiation Protection Products' Lead Lined Doors are constructed using a single layer of sheet lead in the center of the door. Wood cores are laminated under hydraulic pressure on each side of the lead.

Radiation Protection Products' will manufacture Lead Lined Doors to your specifications with leaded glass windows and options as listed. We also supply steel braced, lead lined, hollow metal door frames.

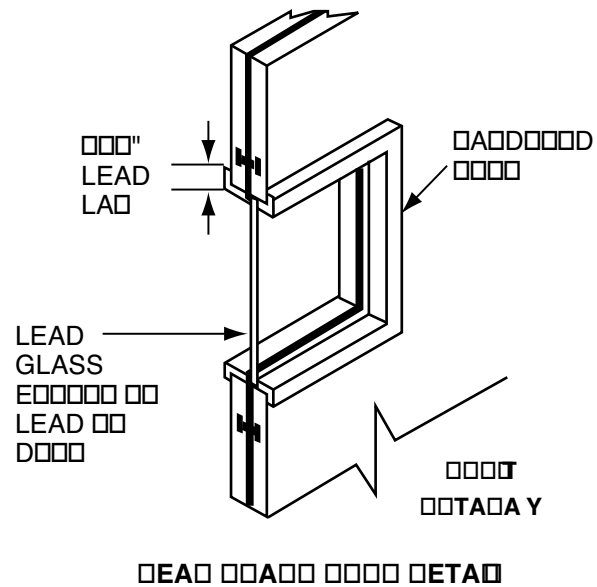
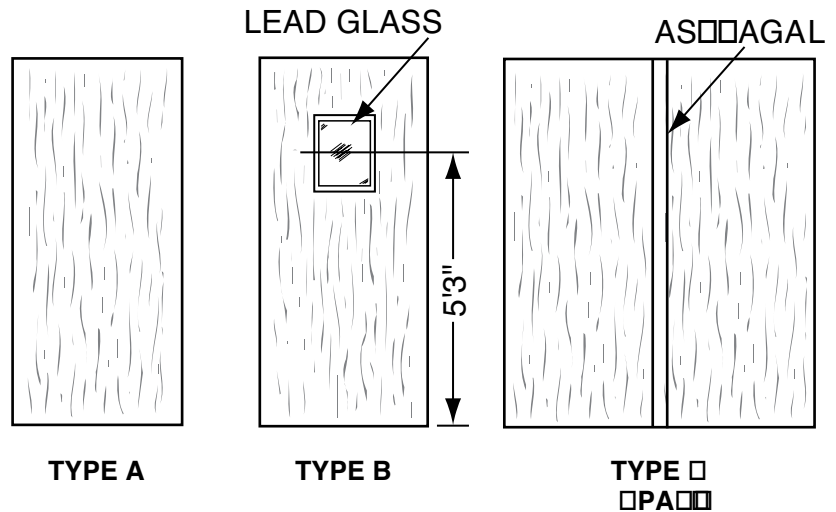

LEAD GLASS must be a minimum of 6" (15cm) from edge of door!



1000 Superior Boulevard, Suite 310 • Wayzata, MN 55391
1.888.RINGRPP (1.888.746.4777) • TOLL FREE FAX: 1.866.554.8445
www.radiationproducts.com

serving the nation's lead needs since 1952 with a full line of radiation shielding products

RADIATION SHIELDING

LEAD LINED SOLID CORE WOOD DOORS (CONT.)

LEAD LINED DOOR ORDERING INFORMATION

Orders for Lead Lined Doors should include the following information:

- Exact width and height
- Swing (see swing selector below)
- Lead thickness
- Any options and locations
- Size and location of leaded glass, W x H
- Bevel (i.e. 1/8" in 2", 3°)
- On double doors, indicate which leaf to receive astragal
- Fire rating (Intertek 20 min.)
- Finish (Veneer or Plastic Laminate)
- Light proof seals

On Pre-hung Doors, include the following additional information:

- Wall thickness
- Hinges and number
- Pivots
- Lock set or latch set
- Size of leaded glass (lead lined glass)
- Swing (see swing selector above)
- Type of frame (i.e. standard hollow metal)
- Lead thickness

Stock sizes: 2'0" x 7'0", 2'6" x 7'0", 3'0" x 7'0", 3'6" x 7'0", 4'0" x 7'0"

Options: Cutout for Leaded Glass, Pre-Hung, Custom Wood Veneer, Plastic Laminate and 20 min. Fire Constructed.

Note: Radiation Protection Products uses 1-1/2 pair Heavy Duty Ball Bearing Steel Hinges. Custom doors quoted upon receipt of specifications.

Radiation Protection Products can supply any type of Plastic Laminate Face Panels, as well as Face Panels of Natural Birch, Red Oak and other wood veneers.

Lead thickness from 1/32" to 1/2" in Wood Doors.

All Lead Lined Doors are manufactured in accordance with N.W.M.A. Industry Standard Special Construction Wood Flush Doors #I.S.I.4-80.

NOTE: All Radiation Protection Products' Doors are custom made, non-cancellable and non-returnable.

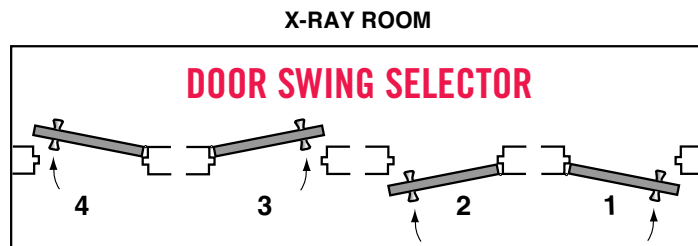

CORRIDOR

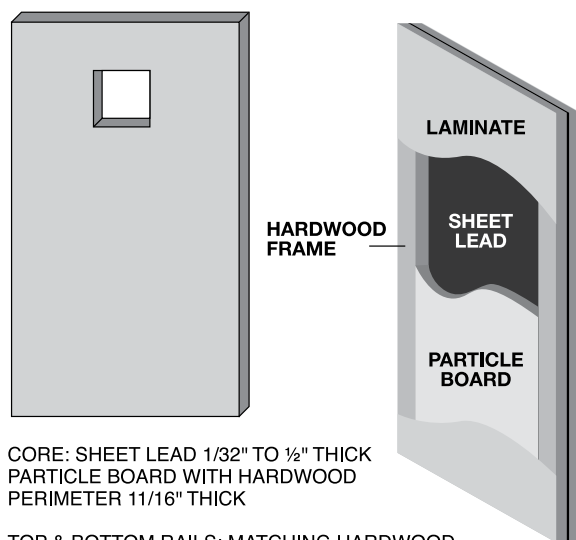

CORE: SHEET LEAD 1/32" TO 1/2" THICK
PARTICLE BOARD WITH HARDWOOD PERIMETER 11/16" THICK

TOP & BOTTOM RAILS: MATCHING HARDWOOD
STILES: MATCHING HARDWOOD
VENEER: HIGH PRESSURE PLASTIC LAMINATE OR WOOD VENEER

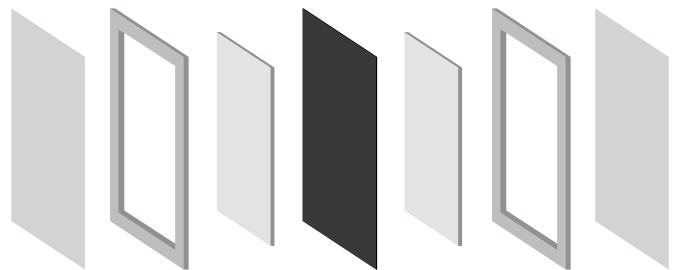

LAMINATE OR WOOD VENEER HARDWOOD FRAME PARTICLE BOARD SHEET LEAD PARTICLE BOARD HARDWOOD FRAME LAMINATE OR WOOD VENEER



1000 Superior Boulevard, Suite 310 • Wayzata, MN 55391
1.888.RINGRPP (1.888.746.4777) • TOLL FREE FAX: 1.866.554.8445
www.radiationproducts.com

serving the nation's lead needs since 1952 with a full line of radiation shielding products

RADIATION SHIELDING LEAD LINED DOOR FRAMES

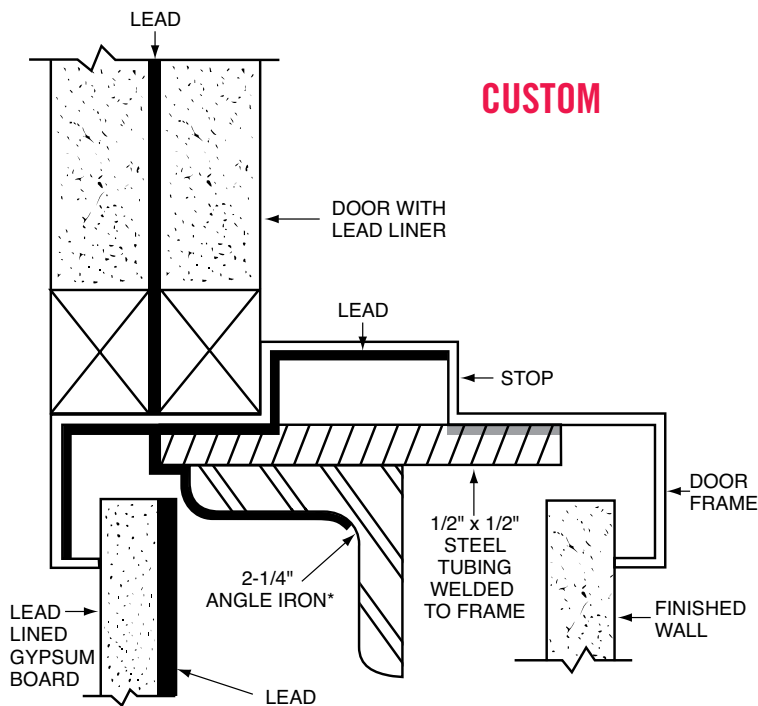
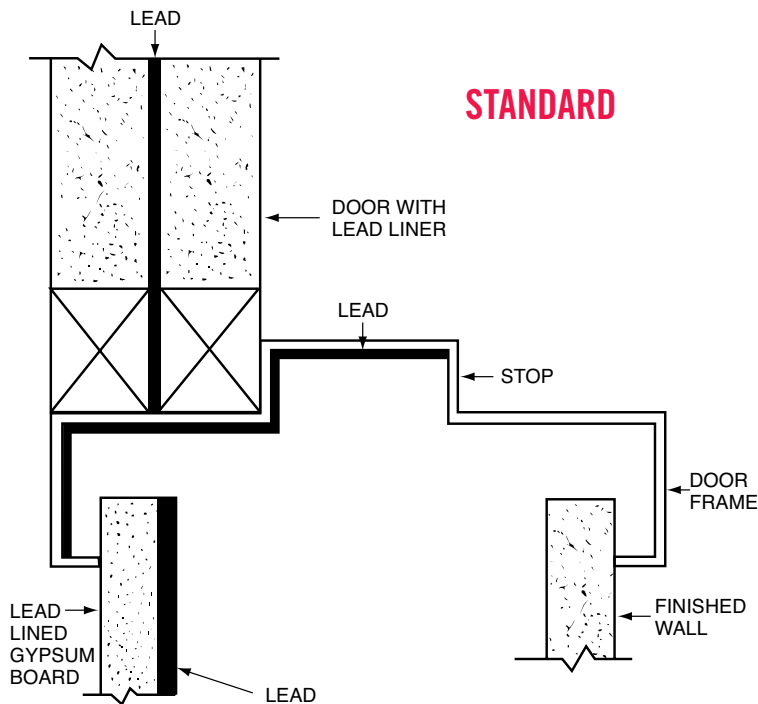

STANDARD LEAD LINED DOOR FRAMES

Radiation Protection Products' Standard Lead Lined Door Frames consist of 16-gauge steel, a 2" face, and a 5-7/8" jamb depth. They are set up and welded and can accommodate up to 1/2" thick lead lining. Our Lead Lined Door Frames are shipped with steel stud anchors that can be attached to the door frame either by welding or with steel fasteners if the lead lining does not exceed 3/32" thick.

We require the use of an Angle Iron for added support on Lead Lined Door Frames that require 1/8" thick lead or higher. These Angle Irons can be spot welded to the steel stud or pre-drilled and bolted to the steel stud.

*We do offer angle irons on our lead lined door frames that are below 1/8" thick lead if requested.

CUSTOM LEAD LINED DOOR FRAMES

We can supply knock down, slip and other lead lined frames upon request. Our Lead Lined Frames can also be equipped with the type of anchors necessary for any given situation (wood stud anchors, masonry strap anchors, etc.). Although our standard Lead Lined Door Frames consist of 16-gauge steel, we offer frames at 14-gauge and 12-gauge as well.

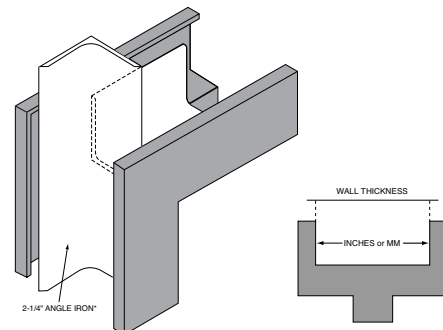

1000 Superior Boulevard, Suite 310 • Wayzata, MN 55391
1.888.RINGRPP (1.888.746.4777) • TOLL FREE FAX: 1.866.554.8445
www.radiationproducts.com

servicing the nation's lead needs since 1952 with a full line of radiation shielding products

RADIATION SHIELDING

LEAD LINED VIEW WINDOW FRAMES

VIEW WINDOW FRAMES

NOTE: Don't cut a lead lined frame opening until frame is at job site!

Steel Telescopic Lead Lined

Standard Steel Telescopic Lead Lined Frames match our Hollow Metal Door Frames. These can be manufactured to accept any thickness of Lead Glass or Lead Acrylic. Standard Lead Lined Steel Telescopic Frames can be steel braced for maximum strength.

The adjustable Lead Lined Steel Telescopic Frames adjust to wall thicknesses of 4-1/4" to 6". Our Lead Lined Steel Telescopic Frames can be supplied with optional voice transmission.

ORDERING INFORMATION

- Leaded glass size-width and height
- Leaded glass thickness
- Baffled voice passage (optional)
- Wall thickness

This information is the same for all lead lined frames ordered.

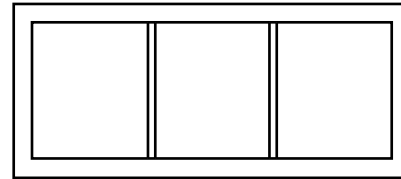

MULLION FRAME

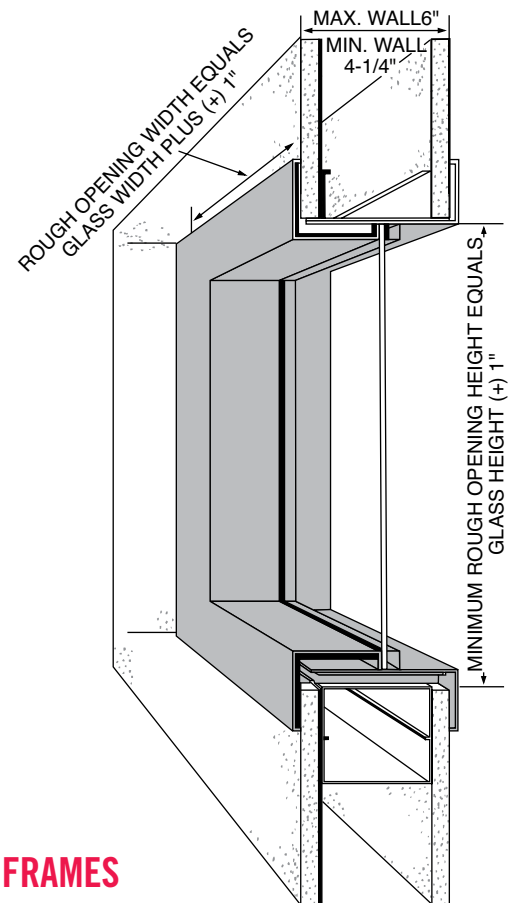
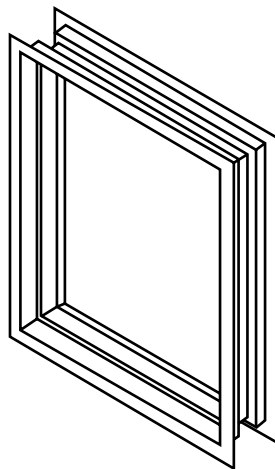

STEEL TELESCOPIC FRAMES



1000 Superior Boulevard, Suite 310 • Wayzata, MN 55391
1.888.RINGRPP (1.888.746.4777) • TOLL FREE FAX: 1.866.554.8445
www.radiationproducts.com

serving the nation's lead needs since 1952 with a full line of radiation shielding products

PARTIAL LIST OF JOBS FURNISHED BY RPP

JOB	LOCATION	CONTRACTOR
Bay Care Med Center	Green Bay, WI	M.A. Mortenson Co.
Montgomery General Hospital	Olney, MD	H.B.E. Co.
Cleveland Clinic	Wooster, OH	Marshall Erdman
Fort Defiance Health Care	Fort Defiance, AZ	Border Glass & Aluminum Empire Lath & Plaster Flintco Construction
Elmdorf Air Force Base	Anchorage, AK	M.A. Mortenson
Mayo Clinic	Rochester, MN	Mulachy Drywall
Mayo Clinic	Rochester, MN	M.A. Mortenson
Mayo Clinic	Rochester, MN	Weis Builders
Hazardous Devices School	Redstone Arsenal, AL	
Travis Air Force Base	Travis AFB, CA	Newberg-Brinderson
Montefiore Medical Center	Bronx, NY	Nastasi & Associates Turner Construction
V.A. Medical Hospital	Minneapolis, MN	M.A. Mortenson Co.
Regional Medical Center	Fayetteville, AR	VVP America Inc. dba Binswanger Glass
GE Test Cells	Waukesha, WI	Olympic Wall Systems
Cessna Airlines	Wichita, KS	
Northwest Airlines	Minneapolis, MN	
Phillips Medical Systems	Scarborough, OH	
Syncor	Hicksville, NY	
U.S.L.E. Base	Sand Island, HI	Paglia Engineering
Smith Hospital	Valdosta, GA	Brasfield & Gorri
V.A. Hospital	Ann Arbor, MI	P.J. Dick
McMinnville Community Hospital	McMinnville, OR	McDevitt Street Bovis
Mary Washington Hospital	Fredricksburg, VA	Centex Rodgers



1000 Superior Boulevard, Suite 310 • Wayzata, MN 55391
1.888.RINGRPP (1.888.746.4777) • TOLL FREE FAX: 1.866.554.8445
www.radiationproducts.com

serving the nation's lead needs since 1952 with a full line of radiation shielding products